

## Current-mode Sinusoidal Oscillator Based-on CCCCTAs and Grounded Capacitors with Amplitude Controllable

Phanida Srakaew<sup>1</sup>, Atthapon Muenthom<sup>1</sup>, Suphaphorn Panikhom<sup>1</sup>, Adirek Jantakun<sup>1</sup>

Received: 12 June 2015; Accepted: 13 July 2015

### Abstract

This article describes the sinusoidal oscillator with amplitude controllable based-on CCCCTAs. The proposed circuits consist of 2 CCCCTAs and 2 grounded capacitors. In addition, the proposed circuits can be electronically controlled of condition and frequency of oscillation with bias current of CCCCTAs. The output signals have high output impedances which are connected or driven to next stages or loads. Furthermore, the output signals can be electronically adjusted the amplitude which is easily and convenient for uses in communication systems or demonstrated in laboratory. The PSPICE simulation results are confirmed that the proposed circuits have a good performance and accordance with the theoretical analysis.

**Keywords:** Sinusoidal oscillator, Current-mode, CCCCTA, Grounded Capacitor

### Introduction

The sinusoidal oscillator is vastly used in electrical or electronic engineering such as the modulation and demodulation circuits of communication system, instrument or measurement system, control system, and in laboratory of communication systems<sup>1-4</sup>. Currently, the passive elements in analogue signal processing circuits are frequently connected to ground since, they require a small area when fabricated to integrated circuits (IC). The grounded capacitor is expediently reduced to the size of an IC<sup>4</sup>. In addition, the grounded capacitor serves to compensate or eliminate the latent capacity that occurs at the terminals of active device and the nodes of the circuit<sup>1-6</sup>. An adjustment of the amplitude of sinusoidal signal is attractive to research and development<sup>4,7</sup>, since it can be applied to communication systems. These are AM (Amplitude Modulation)/ASK (Amplitude Shift Keying) which are classical modulation schemes in communication system. Furthermore, AM is useful in plenty of applications such as AM radio broadcasting and aircraft navigation system. Moreover, ASK also is widely-used in many applications; for example in optical communication<sup>4,7</sup>. AM and ASK are vastly used in laboratories for studying fundamental of electronics/

telecommunication engineering.

The sinusoidal oscillator based-on CCCCTA has been reported in literature<sup>1-14</sup>. For example, the oscillator circuits in<sup>1-6</sup> are compacted and it can be tuned the condition of oscillation (CO) and frequency of oscillation (FO) with electronic method by DC bias current of CCCCTA. However, the proposed circuits in<sup>1-3</sup> afflicted from using 2 output ( $2g_m$ ) in which is the circuits are complicated. Also, the circuits in Ref.<sup>3-5</sup> are using an external passive resistor in which thermal noise may occur and it is difficult to implement in IC<sup>14</sup>. The circuit in<sup>7-13</sup> employs two CCCCTAs and two grounded capacitors which is ideal for IC implementation. Also, it can be electronically/independently adjusted. Unfortunately, the output currents are unfeasible for adjustment of amplitude which is not convenient in AM/ASK systems. The current-mode sinusoidal oscillator in<sup>4,14</sup> introduced FO and CO which can be electronically adjusted by DC bias currents as well as the amplitude can be tuned with biasing of CCCCTA, which is good for AM/ASK communication system. Nevertheless, the output currents can control the amplitude with only a single output.

<sup>1</sup> Department of Electronics and Telecommunication, Faculty of Engineering, Rajamangala University of Technology Isan, Khonkaen Campus, Khonkaen, 40000, Thailand Email: adirek.ja@rmuti.ac.th

The purpose of this paper is to introduce the synthesis of a sinusoidal oscillator circuit based-on CCCCTAs. The usefulness of proposed circuits have the following:

- Using grounded capacitors which are suitable for IC implementation and eliminable the parasitic capacitances at ports/nodes.
- The CO and FO can easily be electronically controlled via DC bias current of CCCCTAs.
- The output currents have high output impedances that are useful for current-mode circuitry configuration.
- The amplitude of output currents can be electronically/independently adjusted with DC bias current, which is suitable for using in AM/ASK systems.

The workability of the proposed sinusoidal oscillator is confirmed via the PSPICE simulation.

### Current controlled current conveyor transconductance amplifier (CCCCTA)

Since the proposed circuit is based on CCCCTA. The characteristics of the ideal CCCCTA are represented by the following hybrid matrix:

$$\begin{bmatrix} I_y \\ V_x \\ I_{z,zc} \\ I_o \end{bmatrix} = \begin{bmatrix} 0 & 0 & 0 & 0 \\ 1 & R_x & 0 & 0 \\ 0 & 1 & 0 & 0 \\ 0 & 0 & 0 & \pm g_m \end{bmatrix} \begin{bmatrix} V_y \\ I_x \\ V_o \\ V_z \end{bmatrix} \quad (1)$$

For the CCCCTA implemented by a bipolar technology, the parasitic resistance is given as

$$R_x = \frac{V_T}{2I_{B1}}, \quad (2)$$

and transconductance is given as

$$g_m = \frac{I_{B2}}{2V_T}. \quad (3)$$

The circuit symbol and equivalent circuit of the CCCCTA are illustrated in (Figure 1(a) and (b)), respectively

### Proposed Circuit

The proposed sinusoidal oscillator is shown in (Figure 2) It consists of two CCCCTAs, two grounded capacitors and one grounded resistor. The use of grounded passive element is advantageous from the point of view of integrated circuit implementation. Moreover, it is found that the oscillator provides high output impedance which can directly drive a load without buffering devices. Using (1) and doing routine circuit analysis, the system characteristic equation can be expressed as

$$s^2 C_1 C_2 R_{x1} R_{x2} + s(C_2 R_{x2} - C_1 R_{x1}) + 1 = 0 \quad (4)$$

From (4), it can be seen that the proposed circuit can produce oscillations if the condition of oscillation is fulfilled

$$C_1 R_{x1} = C_2 R_{x2} \quad (5)$$

If the above condition of oscillation (CO) is satisfied, the circuit produces oscillation with frequency (FO) of

$$\omega_{osc} = \frac{1}{\sqrt{C_1 C_2 R_{x1} R_{x2}}}. \quad (6)$$

Substituting the parasitic resistance  $R_x$  and transconductance  $g_m$  as respectively shown in (2) and (3) into (5) and (6), the CO becomes

$$I_{A2} C_1 = I_{A1} C_2 \quad (7)$$

and the FO is obtained as

$$\omega_{osc} = \frac{2}{V_T} \sqrt{\frac{I_{A1} I_{A2}}{C_1 C_2}} \quad (8)$$

If  $I_{A1} = I_{A2} = I_A$  and  $C_1 = C_2 = C$ , the FO is modified to

$$\omega_{osc} = \frac{2I_A}{V_T C} \quad (9)$$

From (9), it is clear that, the CO and FO can be adjusted simultaneously with electronic tuning by  $I_A$ .

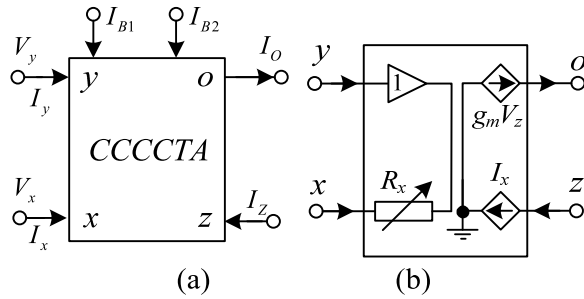

**Figure 1** CCCCTA (a) schematic symbol (b) equivalent circuit

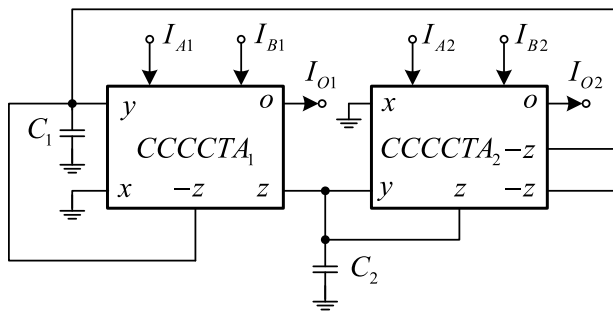

**Figure 2** The proposed sinusoidal oscillator

Simultaneously, the output currents can be obtain as

$$I_{O1} = g_{m1}V_{z1} \tag{10}$$

and

$$I_{O2} = g_{m2}V_{z2} \tag{11}$$

It should be noted that the amplitude of the current output  $I_{O1}$  and  $I_{O2}$  can be electronically controlled by  $I_{B2}$  and  $I_{B1}$ , respectively. Moreover, they have high output impedances which is driven or cascaded to load without using a buffering device. Furthermore, if  $I_{B1}$  or  $I_{B2}$  is information signal, the AM and ASK can be generated at current outputs.

**Simulation results**

To prove the performances of the proposed oscillator, the PSPICE simulation was performed for examination. The BJT technology was simulated by using the parameters of the PR200N and NR200N bipolar transistors of ALA400 transistor array from AT&T. (Figure 3) depicts the schematic description of the CCCCTA used in the simulations with power supplies. The sinusoidal

oscillator was designed with , and . This yields oscillation frequency of 2.2MHz. (Figure 4 (a) and (b)) show simulated output waveforms in transient and steady state, respectively. (Figure 5) shows simulated output spectrum, where the total harmonic distortions (THD) of output currents are about 3.43%. To confirm the output current can be operated of AM, where  $I_{B1}$  was triangular signal with a 50kHz frequency is applied, The AM signal at  $I_{O1}$  is depicted in (Figure 6) Besides, the proposed circuit has functioned as AM generator, where  $I_{B2}$  was sinusoidal signal with a 50kHz frequency shown in (Figure 7) The results are proper with the theoretical analysis in (10) – (11).

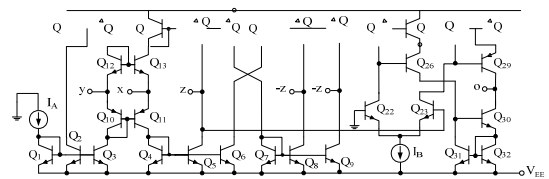

**Figure 3** The internal construction of CCCCTA

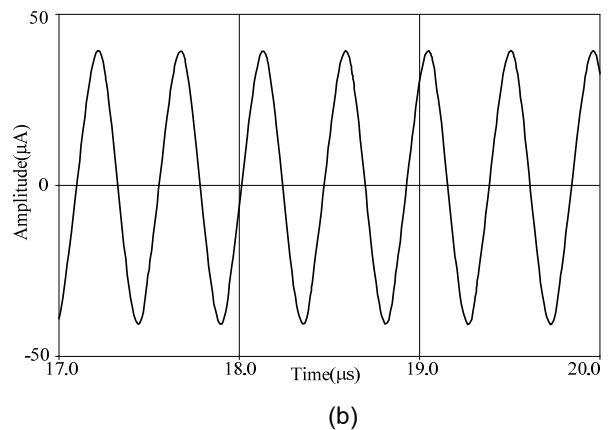
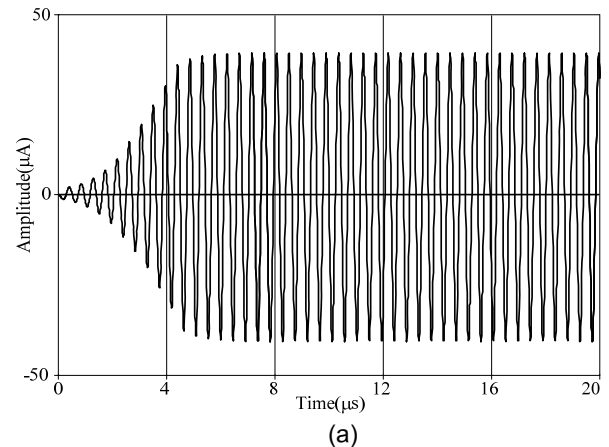

**Figure 4** The simulated output waveforms (a) transient state (b) steady state

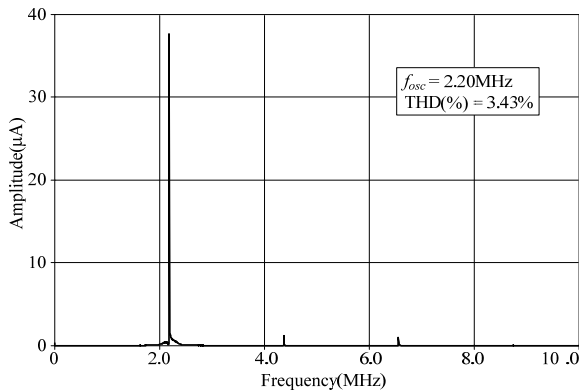

**Figure 5** The simulated output spectrum

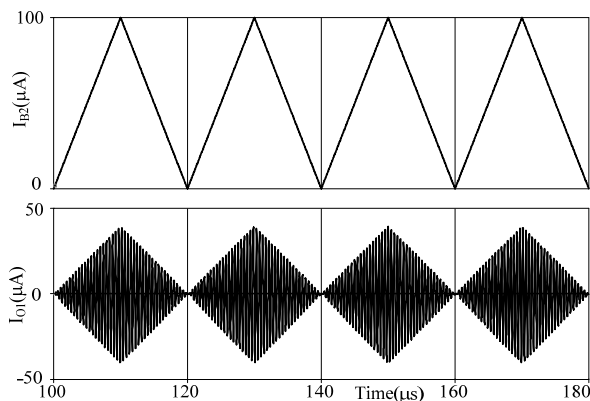

**Figure 6** Results of operation of AM of  $I_{O1}$

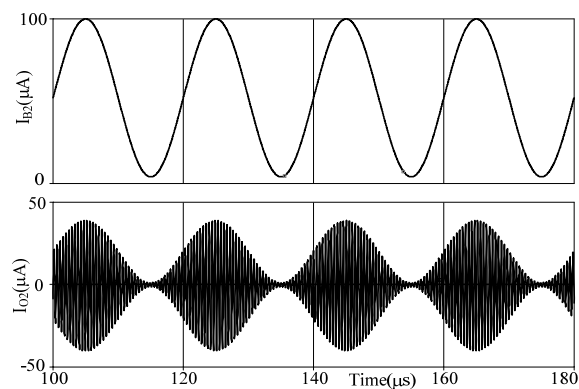

**Figure 7** Results of operation of AM of  $I_{O2}$

## Conclusion

The sinusoidal oscillator using CCCCTAs and grounded capacitors with current controlled amplitude has been presented. It employs two CCCCTAs and two grounded capacitors. Also, grounded capacitors can reduce the fabrication area of IC and compensated the latent capacitance at node and input/output ports of CCCCTAs. In addition, the CO and FO can be adjusted with electronic tuning. Furthermore, the output current

signals can be electronically controllable which are easy for using in AM/ASK communication system. Not only the output current has high impedance but also the circuit can be cascaded without additional current buffers. The performance of proposed circuit are depicted through PSPICE simulation. The results agree well with the theoretical anticipation.

## References

1. Bumronghoke T., Jaikla W., Siriprachayanun M., An Electronic Controllable Simple Current-mode Oscillator using Single MO-CCCCTA and Grounded Capacitors. The 1st international conference on Technical Education, Bangkok, 20-21 Jan. 2010. 217–220, 2010.
2. Thosdeekoraphat T., Summart S., Thongsopa C. Current-mode Sinusoidal Oscillator using Single Dual-output Current Controlled Current Conveyor Transconductance Amplifier (DO-CCCCTA). *Aust. J. Basic & Appl. Sci.*, 2013; 7(8): 230-236.
3. Maiti S., Pal R. R. Dual mode Quadrature Oscillator Employing Single Current Controlled Current Conveyor Transconductance Amplifier. *Int. J. Innovative Research in Science, Engineering and Technology*, 2013; 2: 3015-3112.
4. Jantakun A., Sa-ngiamvibool W., Current-mode Sinusoidal Oscillator using Current Controlled Current Conveyor Transconductance Amplifier. *Rev. Roum. Sci. Techn.– Électrotechn. et Énerg.*, 2013; 58(4): 415-423.
5. Lamun P., Kumngern M., Phasukkit P., Dejhan K., Current-mode Quadrature Oscillator using Single CCCCTA, *Ladkrabang Engineering Journal*, 2554; 28(1): 7-12.
6. Siriprachayanun M., Jaikla W., Current Controlled Current Conveyor Transconductance Amplifier (CCCCTA): A building block for analog signal processing. *Electrical Engineering*. 2008; 90: 443-453.
7. Pisutthipong N., Silapan P., Siriprachayanun M., CC-CCTA Based Current-mode Quadrature Oscillator. In Proc. The Seventh PSU Engineering Conference. Songkla, 20-22 May 2009, pp. 302–305, 2009.

8. Jaikla W., Noppakarn A., Lawanwisut S., New Gain Controllable Resistor-less Current-mode First Order Allpass Filter and Its Application. *Radioengineering*, 2012; 21(1): 312-316.
9. Duangmalai D., Jaikla W., Realization of Current-mode Quadrature Oscillator Based on Third order Technique. *Int. J. on Electrical and Power Engineering*. 211; 2(3): 46-49.
10. Tanaphatsiri C., Jaikla W. Electronically Tunable Four Phase Quadrature Oscillator Employing Current-controlled Current Conveyor Transconductance Amplifiers. 2011 Sixth International Symposium on Electronic Design Test and Application, Queentown, 17-19 Jan. 2011, 89-92.
11. Siripongdee S., Suwanjan P., Jaikla W., Electronically Tuned Current-mode Quadrature Oscillator with Independently Controllable FO and CO. *Recent Advance in Communications Circuits and Technological Innovation*. Paris, 2012. 213-216.
12. Pitaksuttayaprot K., Jaikla W., Implementation of Second Order Current-mode Quadrature Sinusoidal Oscillator with Current Controllability. *World Academy of Science Engineering and Technology*. 2013; 77: 476-478.
13. Singh S. V., Gupta G., Chhabra R., Nagpal K., Devansh., Electronically Tunable Voltage-mode Biquad filter/oscillator Based on CCCCTAs. *International Journal of Computer Science and Information Security*, 2010.
14. Sa-ngiamvibool W., Jantakun A. Quadrature Oscillator using CCCCTAs and Grounded Capacitors with Amplitude Controllability, *International Journal of Electronics*, 2014; 101(12): 1737-1758.